

# **EX14-50**

## **INSTALLATION INSTRUCTIONS**



# WARRANTY

Plane Power, Ltd. warrants its alternators and voltage regulators for a two-year period from date of purchase to be in good working order and free of material defects. Plane Power, Ltd. retains the right to rebuild or replace any alternator or voltage regulator if it fails under the terms of this warranty and *only* if the customer's original alternator or voltage regulator is sent to Plane Power for evaluation, along with a dated copy of the sales receipt. This alternator or voltage regulator must be shipped directly to Plane Power per instructions found in this warranty agreement at the customer's expense for warranty evaluation.

If the alternator or voltage regulator is found to have failed under the terms of this warranty, Plane Power will take the appropriate action of either rebuilding or replacing the alternator or voltage regulator. Customers will be responsible for any additional expedited shipping charges. Plane Power, Ltd. reserves the right to insure all alternators and voltage regulators for loss or damage during shipping directly to the customer.

Plane Power, Ltd. makes no warranty as to suitability of its products for the intended application.

To be considered eligible for warranty consideration, **DO NOT PURCHASE A REPLACEMENT ALTERNATOR OR VOLTAGE REGULATOR FROM A DEALER.** Plane Power, Ltd. will not at any time offer a form of a warranty credit for replacement alternators or voltage regulators purchased through a dealer. All warranty claims must be handled directly by Plane Power, Ltd.

If you suspect an alternator or voltage regulator to be defective and in need of service, call Plane Power, Ltd. at 877-934-5700 for a return authorization number.

Alternators and voltage regulators returned to the factory via UPS with the valid return authorization number will usually be rebuilt or replaced the same day as received. However, other carriers and/or circumstances may increase the turnaround to 1-2 days.

---

## Warranty Details

Plane Power, Ltd. warrants its alternators and voltage regulators to be free from defects in material and workmanship under normal use and operation for a period of two years from date of purchase. Plane Power, Ltd. cannot and never will warrant damage to non-alternator or voltage regulator components or related expenses including labor, inconvenience, transportation or loss of business due to any alternator failure.

---

## Plane Power, Ltd. warranty is *void* if:

- An alternator or voltage regulator is improperly installed.
- An alternator or voltage regulator is used for the wrong application.
- Customer tries to service the alternator or voltage regulator in the field by removing or replacing any of the components not specifically instructed and/or supplied by Plane Power, Ltd.
- The alternator or voltage regulator is determined to have failed by application of voltage in excess of the amount specified on the data plate.
- The alternator or voltage regulator is damaged by impact, shock or excessive abuse, (i.e. dents, large scratches, bent components) actual physical evidence not in conjunction with defective components, design or workmanship.



# REVISIONS

LTR.	DESCRIPTION	DATE	APR.

## EXPERIMENTAL 14 VOLT 50 AMP INTERNALLY REGULATED GEAR DRIVEN ALTERNATOR WITH INTERNAL OVER-VOLTAGE PROTECTION

NOTE: BOTH GASKETS SUPPLIED USE APPROPRIATE GASKET FOR YOUR ENGINE.

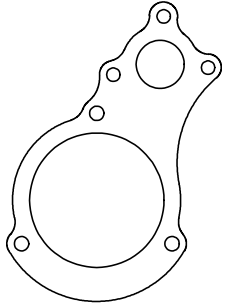

GASKET  
TCM P/N 35019  
or  
SUPERIOR AIRPARTS  
SA35019

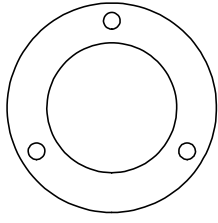

GASKET  
TCM P/N 649984  
or  
SUPERIOR AIRPARTS  
SA352066

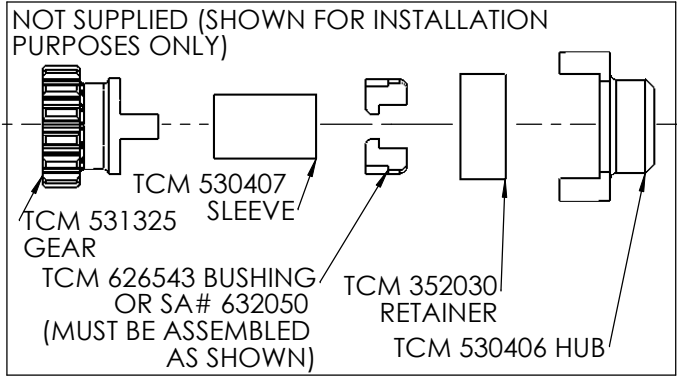
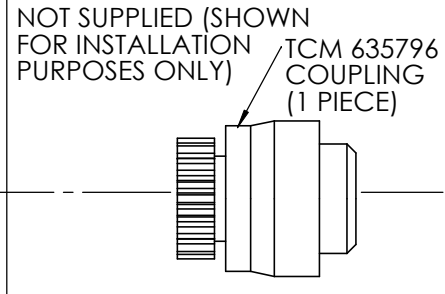
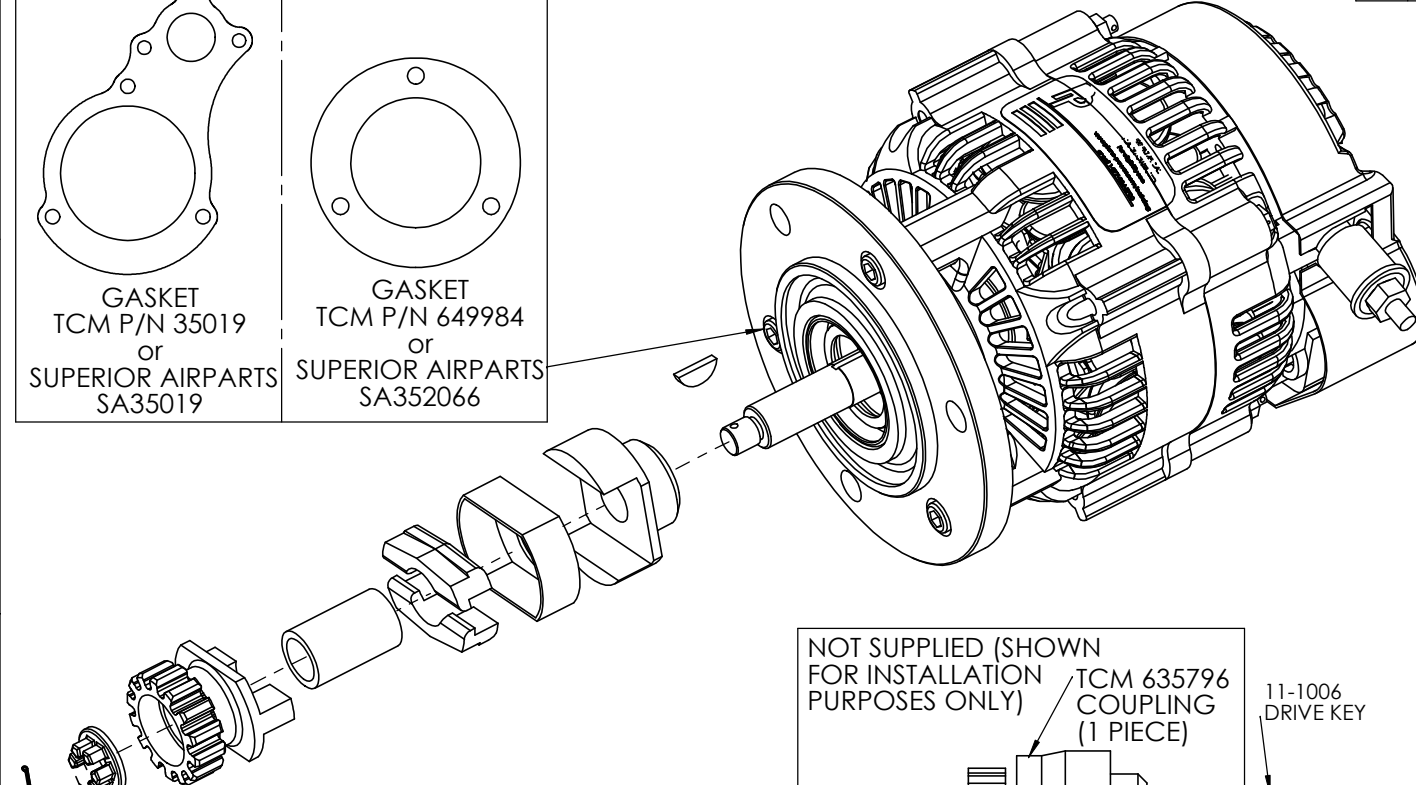
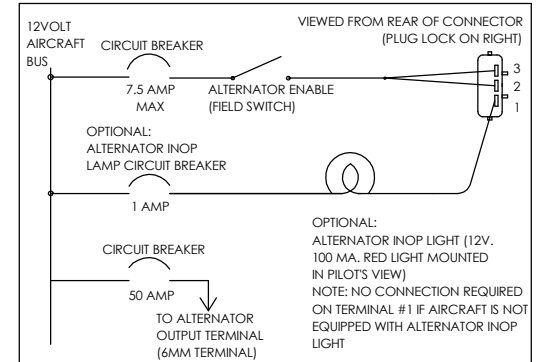
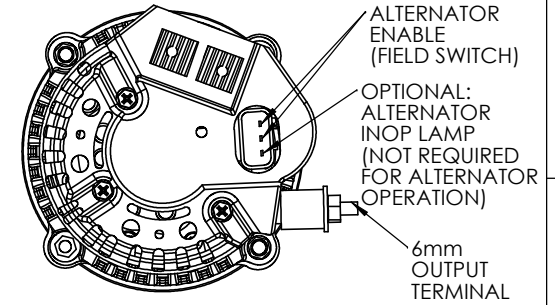

1.87"

75"

**Plane Power** \*Experimental\*  
PLANE POWER, LTD.  
For eligibility see  
[www.plane-power.com/catalog](http://www.plane-power.com/catalog)  
or call 1-877-934-5700

**MODEL NO. EX14-50**  
**SERIAL NO. EX14-YWSN**  
**VOLTAGE 14**

**PLANE POWER, LTD.**  
GRANBURY, TEXAS

**EX14-50 INSTALLATION INSTRUCTIONS**

DRAWN BY: **B. JOWERS** DATE: **5/17/07**

MATERIALS: DWG. NO. **E11-1001** REV.

## **EX14-50 INSTALLATION INSTRUCTIONS**

**READ AND THOROUGHLY UNDERSTAND ALL OF THE INSTALLATION INSTRUCTIONS BEFORE BEGINNING INSTALLATION OF THIS KIT.**

**NOTE: IF AIRCRAFT DOES NOT HAVE A CIRCUIT BREAKER OR CURRENT LIMITING DEVICE IN THE GENERATOR OUTPUT WIRE AND REGULATOR INPUT TERMINAL PER AC43.13-1B, DO NOT INSTALL THIS KIT.**

1. **ENSURE THAT ALL POWER IS REMOVED FROM THE EXISTING GENERATOR CIRCUIT, IF UNSURE DISCONNECT THE AIRCRAFT BATTERY!** Remove existing generator and mounting gasket, inspect mounting surface and mounting studs for any abnormalities. Correct all issues before installing EX14-50 Alternator Kit.
2. Remove drive gear assembly from old generator.
3. Inspect Gear, Sleeve, Retainer and Hub for Airworthy condition. Discard old Bushings TCM Part Number 626543 (Bushings must be replaced with new) and any worn or damaged parts or assemblies.

**NOTE: IT IS THE RESPONSIBILITY OF THE INSTALLER TO THOROUGHLY INSPECT AND PROPERLY INSTALL THE GEAR ASSEMBLY. DAMAGE TO THE ALTERNATOR FROM THE INSTALLATION OF WORN, DEFECTIVE OR IMPROPERLY INSTALLED PARTS WILL VOID EX14-50 WARRANTY AND MAY CAUSE ENGINE DAMAGE.**

------(Refer to Page 1 and Figure A)-----

4. **ASSEMBLE DRIVE GEAR ASSEMBLY WITH 2 NEW BUSHINGS TCM P/N 626543** on alternator shaft. Ensure Bushings and Drive Key are properly installed in shaft.
5. Torque Shaft Nut TCM P/N 530412 to Minimum torque of 180 inch Lbs. and install cotter pin #MS24665-132. If cotter pin will not pass through drilled hole in shaft slowly increase torque to align hole. **DO NOT EXCEED 220 INCH LBS.**
6. Install alternator on engine with new gasket TCM P/N 35019 or P/N649984 depending on engine model. Ensure that alternator drive gear meshes to engine gear without forcing or binding.
7. Reinstall 3 flat washers, lock washers and nuts that were removed in step 1.
8. Hand tighten nuts evenly and check that the alternator fits evenly to the engine case without any force or binding.
9. Slowly increase the torque on the 3 mounting nuts using a crosswise pattern until a torque of 200 Inch Lbs. is achieved. **Check drive gear lash by carefully moving the EX14-50 cooling fan on rotor back and forth(Typical lash .075"). If no lash is detected remove EX14-50 and correct the cause before proceeding.**
10. Install output (B+) wire and torque to 50 inch Lbs. **Ensure that the output wire is of sufficient size to carry more than 50-Amps and that it is connected to the aircraft buss through a 50-Amp circuit breaker. Refer to AC43.13-1B for acceptable methods, techniques and practices if needed.**
11. Wire the Enable/ Field plug as shown on installation drawing. **THE ENABLE WIRE MUST BE WIRED TO A 7.5-AMP MAX CIRCUIT BREAKER.** The optional Alternator Inoperative Lamp is not required for alternator operation but is recommended if the aircraft does not have an alternator or voltage monitoring system.
12. Check the security of all wiring and ensure that there is no interference with any control movement.



